

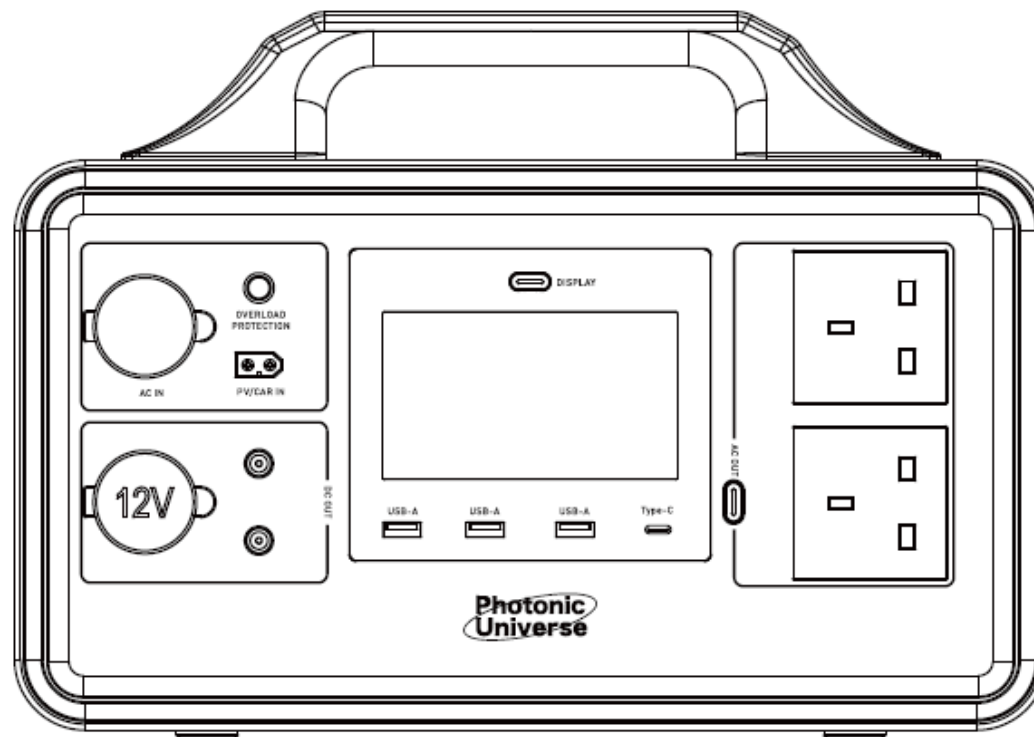

P500S

Power Station Instruction Manual



Attention! This manual is generally used in energy storage system products with an AC output range of 100-240V/50Hz-60Hz. The actual specifications of the product, especially the AC output, will be customized according to different countries, regions and users. Please read this manual carefully before using this product.

LED Display Switch

Short press to control LED display on/off
Long press 2s clears Bluetooth binding

Input

1. AC: 500W Max.
2. Solar XT60: 200W Max.
3. Car Charger: 120W Max.

Output

1. USB-C: PD 100W
2. USB-A 1/2/3: 12W
3. Car Charger/DC Output shared 120W
4. AC: Stable at 500W, Peak at 1000W

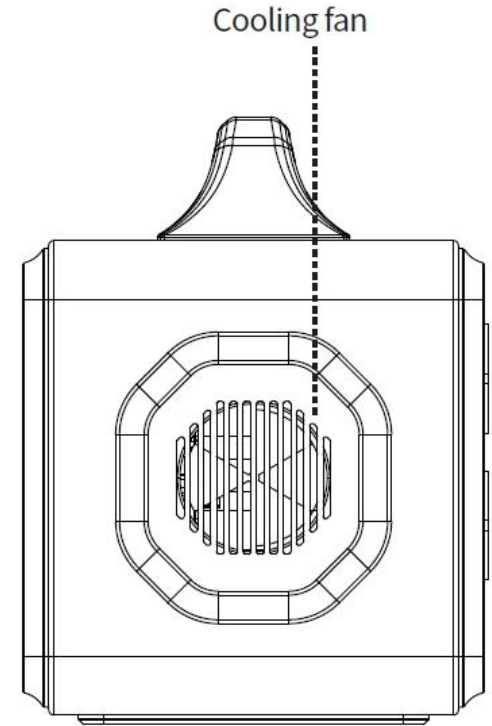
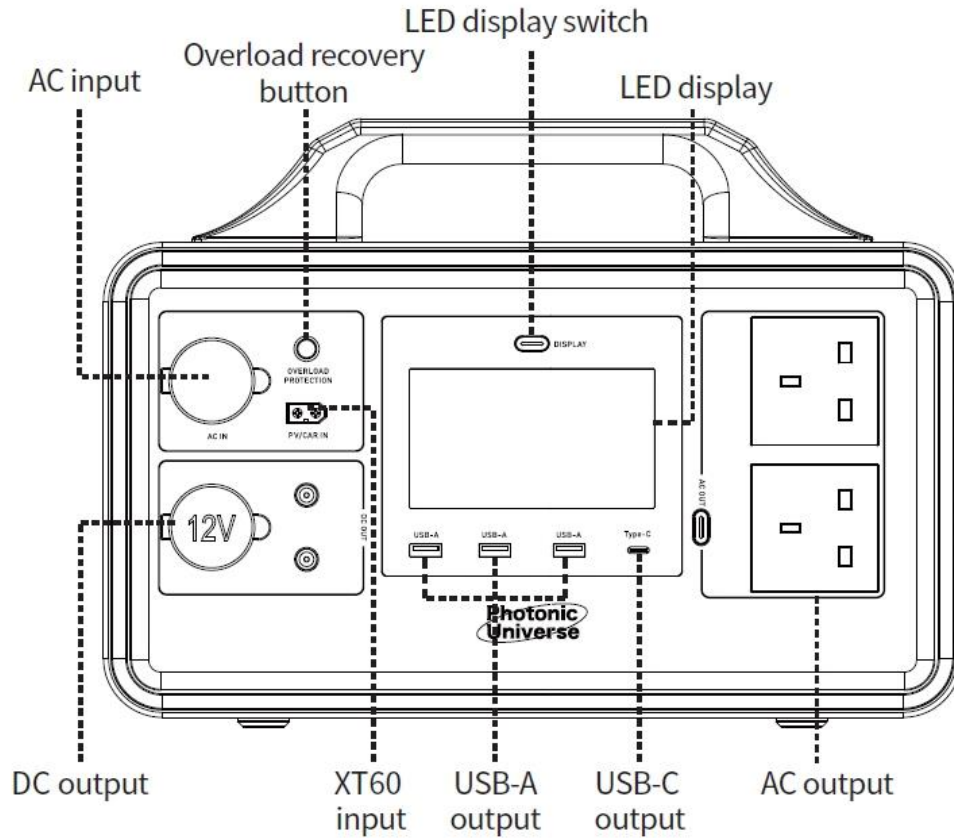

Chargeable device

USB Output: Smartphone, Smartwatch, Digital Camera, E-reader, Tablet, etc.

12V Car charger Outlet: Light, Car Adaptor, etc.

AC Output: Laptop, LED screen, Household appliances, etc.

AC Output:



LED lights
12V/5W
(85 h)



Camera
16WH
(25 times)



Laptop
60WH
(7 times)



TV
110W
(3.8 h)



Drone
60WH
(7 times)



Fan
45W
(9.5 h)



Blender
250W
(1.7 h)



Projector
100W
(4.3 h)

USB Output:



Smartphone
2851mAh
(40 times)



Gaming console
4310mAh
(27 times)



Tablet
28.65Wh
(15 times)

DC Output



Car charger
Outlet Car
refrigerator
65W (6.5 h)

Charging Method



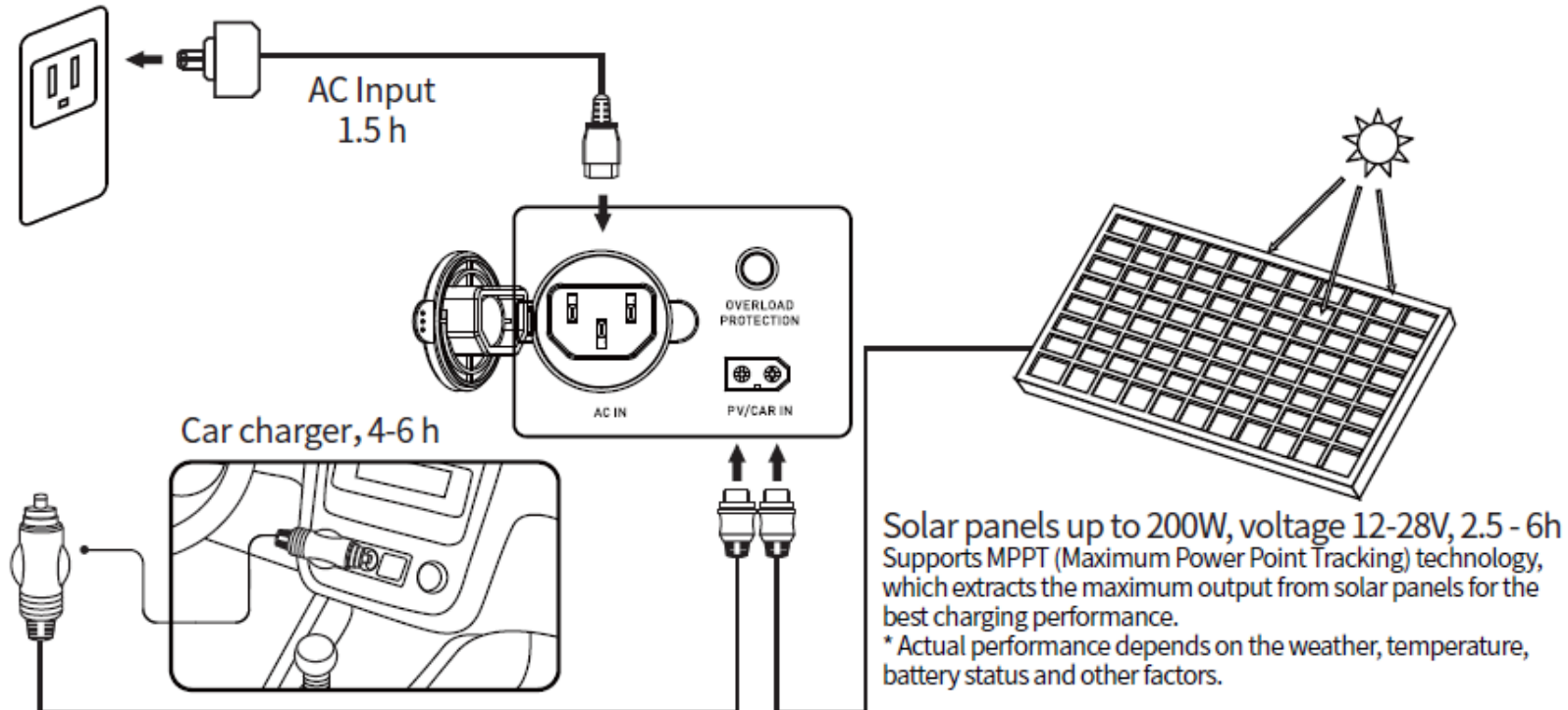







Before using or storing the product, please charge it with the charger cable. When connected to the mains for charging, the LED screen will light up and display the current power of the product. When the LED screen shows that the power is 100%, it means full.













Operating Temperature range

Low temperatures may reduce the battery capacity of the product. The product can be charged within a temperature range of 0°C to 40°C. If charging is required at temperatures below 0°C, first place the product in a warm environment before connecting it to a power source (AC or solar). For discharging (to run other devices), it can operate in temperatures ranging from -10°C to 40°C.

Specifications

									
Capacity	Weight	Dimension	AC Input	Solar Input	Car charger Output	DC Output	USB-C Output	USB-A Output	AC Output
518Wh (27000mAh/ 19.2V)	7.4 kg	335*180* 236mm	500W Max.	XT60 200W Max.	120W Max.		PD100W	12W Max.	Stable at 500W Peak at 1000W

								
Battery Cell	Cycle times	Storage Temperature	Operation Temperature	Charging Temperature	Protect system	Bluetooth	Warranty	Compliance
LiFePO ₄ Battery	3000times	-10-45°C	-10-40°C	0-40°C	Overcharge protection, Over-discharge protection, Overcurrent protection, Over temperature protection, Short circuit protection, Overvoltage protection.	Bluetooth 5.0 with App	12 months	CE  RoHS

Packing list

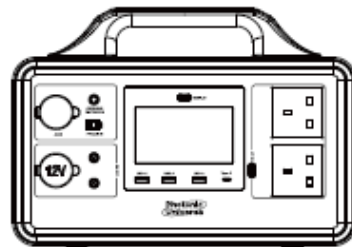

Power station

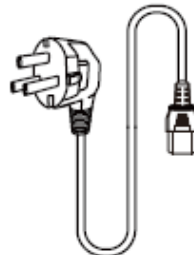

AC charger cable



User manual

Use Instructions

How to use it:

1. Press the switch button next to the port you would like to use.
2. When the indicator light next to the port is lit up, the output will be turned on, and the corresponding device can be powered.
3. AC output is stable at 500W (peak at 1000W). If the rated power of the devices you are charging exceeds the maximum power, the power supply will be automatically turned off to protect the product from overload.
4. If the AC output is not loaded for 2 hours, it will be turned off. When the DC output is unloaded for 12 hours, it will be turned off.
5. If the product is not used for a long time, it should be recharged every three months. It is better to keep the level of charge at 60%-80% (rather than 100%) and store it in a cool and dry place.

Attention! If the AC port is not in use, please turn it off to save power.

LED Screen Instructions

The LED screen of this product displays the product usage status. When any function is activated, the screen will light up. When the screen display is not needed, you can press the button to turn off the LED screen.

1. Overcharge alarm
2. Temperature alarm
3. Fan identification
4. WIFI&Bluetooth status display
5. Charging status display
(Blinking: charging medium/Steady on: full)
6. AC output power
7. DC output power
8. Battery capacity
9. Battery level display
10. Solar charge power
11. AC charge Power

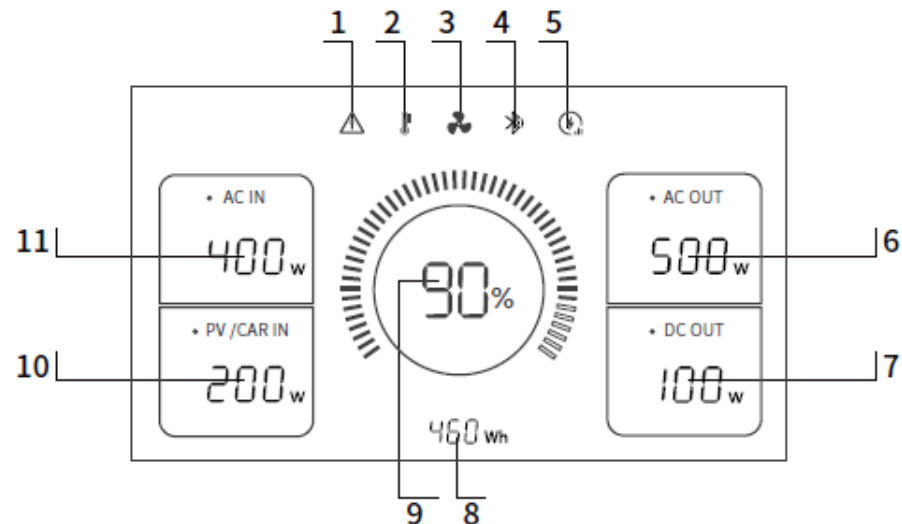

APP Instructions

You can connect to your power station from your smartphone via Bluetooth or Wi-Fi using the Power Zero app. The app displays the product's status and allows you to monitor charging and energy usage in real time. It is compatible with smartphones running Android 6.0 or iOS 12.0 and higher.

*The app is constantly improving. Therefore, the description in this user manual may not be consistent with the most recent version of the app that you find available.

Download the app

- Please download the app Power Zero from Google Play or App Store directly from your phone.

Login

- After the installation, click on the app icon to enter the login interface. If you are opening the app for the first time, you will need to select the server closest to your location.
- For a new account, select “Register” and enter your email address. A confirmation code will be sent to your email address. Enter this code in the app to confirm your email and set a password.
- Log in with your email address and the password you set.
- If you have forgotten your password, select "Forgot Password?" and reset it.
- If you need to access the server selection list again, click on the link in the upper-right corner. Note that if you change the server, the app will no longer retrieve historical data for your device.

Adding devices

- After successful login, select "Add Device" in the upper left corner to add a device.
- If a QR code is available on your device, click on “Add via QR code” and scan the QR code
- Alternatively click “Add via Bluetooth”, enable Bluetooth on your smartphone as well as location sharing, and select the device in your Bluetooth phone interface to add it directly.
- Once the device has been successfully added, the name of your power station will be displayed on the homepage.
- Clicking on different devices in the device management page will switch the connection to those devices. To modify and delete devices: if you are using iOS, swipe left; if you are using Android, long-press on the device list.

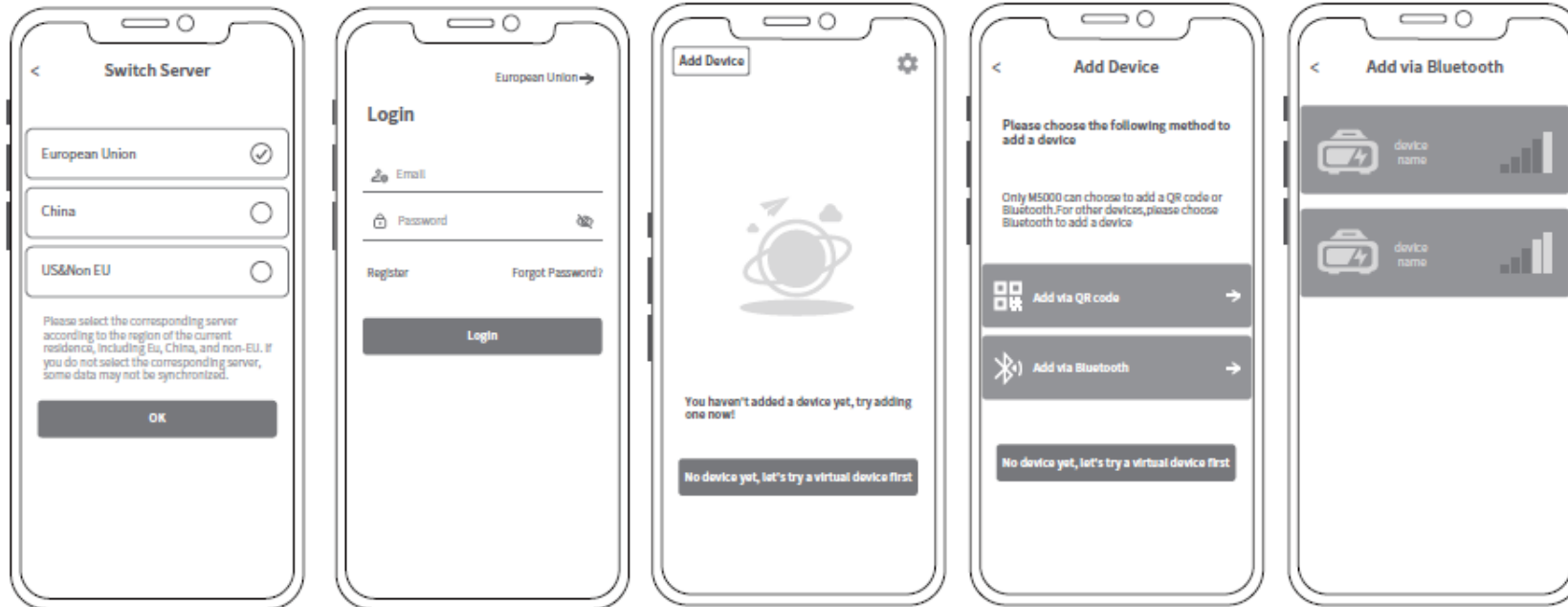

Station homepage

Real-time display of device status: alarm, fan status, Bluetooth / WiFi status, battery remaining, DC/AC output power, PV/AC input power.

App settings

Select the settings wheel at the top right to change settings or get information:

- Account Management.
- Set AC idle standby time.
- Set DC idle standby time.
- Share device.
- Wireless network settings.
- App and device information.



Fault diagnosis

If your appliances cannot get power from this portable station, please follow the steps below:

1. Ensure that the output is enabled, and the LED indicator light on the power button is on.
2. Check the LED power display for battery level. If it is 20% or less, please charge the station.
3. Ensure that the power of your devices does not exceed the maximum output of the station.
4. Confirm that the device power cable you are using is properly plugged in and has good contact.

Frequently asked questions

Q: What is the battery type?

LiFePO4 battery.

Q: Can the product be taken on the aircraft?

Typically not. According to airline transportation regulations, lithium batteries with a capacity over 100Wh cannot be taken on board aircraft. Please check with your airline for more information.

Q: Can the station be charged with solar panels from a different brand?

Yes, it can. Please use solar panels that meet the following specifications for charging:

- Voltage range: 12-28V DC
- Rated output power: maximum 200W.

This product uses MPPT (Maximum Power Point Tracking) technology, which maximises energy and efficiency of solar panels. Actual performance depends on weather conditions and will significantly decrease in cloudy weather or shaded areas.

Q: How to estimate the working time of the product?

This depends on the power consumption of appliances you are using. If it is stable (the same device is powered), the LED display of this product can help estimate the remaining working time by checking the battery percentage and observing how quickly it decreases.

Warranty information

This warranty covers defects in materials and workmanship under normal use of the product. The warranty described herein is the sole, exclusive and comprehensive warranty for this product. We do not authorise anyone else to provide additional warranties or assume any other liabilities.

Warranty period

The product warranty period is one year. In all cases, the warranty period starts from the date of purchase. Proof of purchase and other supporting documents, information, or verification may be required.

The following conditions are not covered under the warranty:

1. Damage to the product occurring after use, and any type of mechanical impact.
2. Unauthorised disassembly, modifications or repairs performed on the product.
3. Performance issues caused by misuse, abuse, or negligence.
4. Damage caused by humidity, contact with water or liquids, corrosive substances, excessive heat, or damage resulting from natural disasters, lightning, accidents, or other abnormal events.

How to get the warranty service

Please contact us by phone or email with as much information about the problem as possible, including photos and videos if applicable. For any eligible warranty issues, our technical team will provide a Return Merchandise Authorisation (RMA) and return instructions for the product, including the address where the product can be returned for warranty service.

Chemical composition of toxic and harmful substances

Part Name	Toxic and harmful substances or chemical elements						
	Pb	Hg	Cd	Cr(VI)	PBB	PBDE	
Product shell	○	○	○	○	○	○	O: The content of hazardous substances in homogeneous materials all components are limit requirement specified in GB / T 26572. X: The content of hazardous substance in at least one of the average materials of the part exceeds the limit requirement of GB-T 26572, and there is no mature alternative in the industry at present, which meets the environmental protection requirements of the EU RoHS directive.
Circuit module	X	○	○	○	○	○	
button	○	○	○	○	○	○	This information for reference purposes only and does not represent a binding agreement. Product (Colour, Size, OSD, etc) in kind prevail.
Small hardware	○	○	○	○	○	○	
Charging Cable	○	○	○	○	○	○	
Battery	○	○	○	○	○	○	

Important safety information



Warning!

Please note the following safety precautions.

- A. Do not cause a short-circuit. Please avoid storing the product together with metal objects, such as coins, jewellery, keys, etc.
- B. Do not expose the product to liquids or heat, including placing it near a fire, engine, leaving it in the rain, or under direct sunlight etc.
- C. Do not place the product in a highly humid or dusty environment.
- D. Do not disassemble the device in any manner.
- E. Do not drop, place heavy objects on it, or subject the product to strong impacts.
- F. Always place this product in a location where it cannot be reached by people who lack experience and relevant knowledge, unless they are supervised by personnel responsible for their safety.
- G. Ensure the product cannot be accessed by children.
- H. Do not cover the product (such as with towels or clothing) when using it or charging it.
- I. The product may get hot when it is being charged. This is normal but you must exercise care.
- J. Do not leave this product without charge for an excessive period of time.
- K. Disconnect your device from the product when the power is no longer needed.
- L. Never use damaged cables or sockets, and never touch any live conductors to avoid electric shocks.
- M. Dispose of the product according to the local regulations. Never put it into the general rubbish, to avoid risks of explosion or pollution.
- N. The product is intended only for emergency and temporary power supply. It cannot replace a standard DC power supply or AC power supply for household appliances or digital equipment.

Photonic Universe Ltd
TMS House, Cray Avenue, Orpington,
Kent, BR5 3QB, United Kingdom
Tel: +44 (0) 203 150 11 11
Email: info@photonicuniverse.com

v. 1.1 Made in China

RoHS



**UK
CA**

